

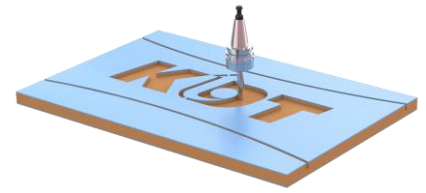

FLAT BED CNC



KN3409DE



KN3409DE Flat Panel Nesting CNC.
Strong, Precise and Outstanding value



– an Introduction:

KDT are a major manufacturer of panel-based machinery with over 20 years of technical knowledge and experience. They export successfully to all major world markets a comprehensive range of Edgebanders, Beamsaws, Panelsaws, Flow through production lines, CNC routing and Drilling machines. Annual production exceeds 19,000 machines

Click here and take a look...

<https://www.youtube.com/watch?v=xoqp9XiLNds&t=10s>

KDT machines are built to work hard and designed to last.



www.ledamachinery.com.au
All features and product specifications subject to change without notice

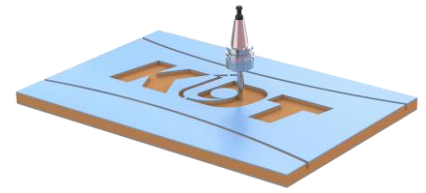

KN3409DE Flat Panel Nesting CNC. Strong, Precise and Outstanding value

Strength and reliability in an affordable package
Productivity boosting auto 'push off' is built in
Auto loading suction system and panel aligners are standard
'WoodSystem' Software is included



Option to upgrade to a label, load and unload Work cell!



See auto line in action:

[https://youtu.be/ tQ_bLYPaMA](https://youtu.be/tQ_bLYPaMA)



www.ledamachinery.com.au
All features and product specifications subject to change without notice

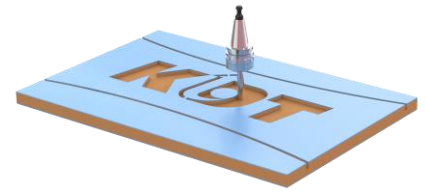

KN3409DE Flat Panel Nesting CNC. Strong, Precise and Outstanding value

DESIGN IN DETAIL:

Machine Frame.

A CNC relies on the strength and rigidity of its frame

Frame alone weighs 1500kg
Total machine weight 3500kg

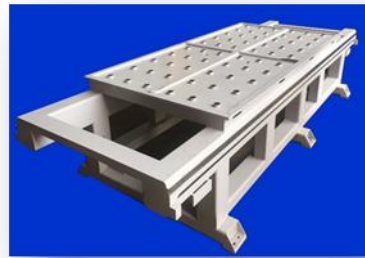

160mm x 160mm X 8mm thick steel beams are the key around which the frame is built, and the guides mounted.

CNC welded and carefully heat treated to relieve any welding stress, then precision machined on a 5-axis machining centre to guarantee the accuracy of the bed and stability of the guide rails

Robotic welding. The strength depends on the accuracy and stability of welding. The robot produces high-precision welding, evenly connecting the parts without overheating the seam. Guarantee of the quality of welded joints.

The welded frame and bed are **Annealed:** relieving internal stress, hardening, preventing deformation and increasing the reliability of welds. The bed is heated up to 590 ° C and then slowly cooled, which stabilizes the metal

Annealing is a costly process as a large amount of electricity is consumed and the production period is increased. KDT remain true to traditions and fundamental scientific principles.

After annealing, the bed is **sandblasted**

In addition to cleaning contaminants and knock removing the oxides of the metal itself > prepared for the application of paint.

The whole is always more than the simple sum of its parts!

Each KDT machine test runs at idle for 10 to 12 hours. Engineers carefully check the operation the interaction of components and issue a certificate of completion

This construction is normally reserved for far more expensive CNC's and is fundamental to accuracy and long-life precision



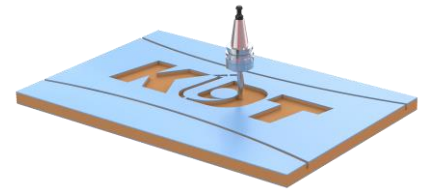

KN3409DE Flat Panel Nesting CNC. Strong, Precise and Outstanding value

Table vacuum system – crucial for a good result

Poor vacuum means wasted panels and time.

The KN3409DE has a larger open vacuum chamber area under the Matrix table that significantly improves vacuum distribution.

7 Vacuum zones - selected from the front of the machine direct vacuum where it's needed

When auto loading the x and y travelling stops and rails automatically 'zero' your panels ready to commence machining.

Extra sturdy guide rails with safety sensors prevent injury or damage should a stop not retract.



Table bed is constructed from 12- 20mm thick steel



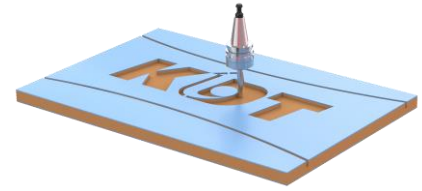

KN3409DE Flat Panel Nesting CNC. Strong, Precise and Outstanding value

Strong and reliable Vacuum.

A BECKER dry vacuum pump lower maintenance costs without loss of vacuum in hot environments. A gauge shows the Vacuum being achieved

A powerful 5.5kw pump delivers 244 cubic m hour and with the KDT large chamber table design delivers maximum vacuum evenly across the selected table area.

Safely secured workpieces - eliminates annoying, wasteful suction loss problems.

KDT pumps are external to the machine frame not under it. Heat build-up dissipates and maintenance is far easier, reducing costs.

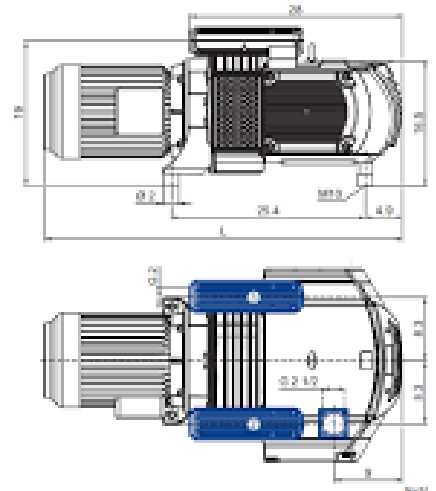

Superior Gantry design.

www.ledamachinery.com.au

All features and product specifications subject to change without notice





KN3409DE Flat Panel Nesting CNC. Strong, Precise and Outstanding value

The gantry is supported and servo driven on both sides. This eliminates sag and flex providing superior accuracy and rigidity with greatly reduced vibration. This in turn delivers faster cleaner routing, improving finish

Flexing or twisting of the gantry is eliminated by a 250 x 200mm x 8mm thick top beam with solid cast iron (not alloy) end supports.

The smooth-running gantry traverses on linear bearings along precision ground flat rails. Smooth travel with low friction for reliability.

The guides are automatically lubricated from a centralised system in X and Y. Separate manual Lubrication for the Z axis is included.

Reduced friction and power consumption with prolonged service life.

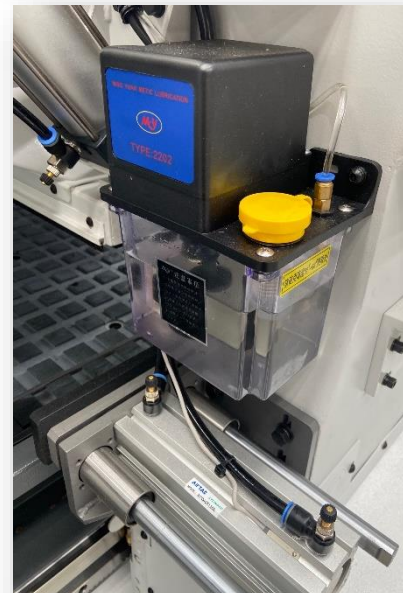
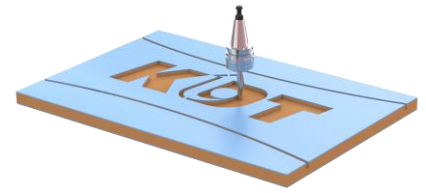

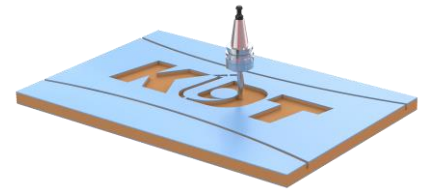

KN3409DE Flat Panel Nesting CNC. Strong, Precise and Outstanding value

The best drives guides and cables

The gantry is driven by 2 powerful Delta Servo 1.5kw drives electronically linked and coupled to reduction planetary gearboxes.

The Y axis is driven by a 1.5kw Delta servo drive coupled to a reduction Gearbox.

These drive the gantry and machining group along heavy duty 30mm helical rack and pinion systems with high precision Lineal guides

The helical rack and pinion system ensures rack teeth are always engaged fully and eliminate backlash. This delivers smooth acceleration and deceleration, increased accuracy with significantly reduced vibration and noise.

Z axis drive is also a 1.5kw servo controlling a recirculating ball screw and twin widely spaced linear guides for smooth precise and quiet positioning

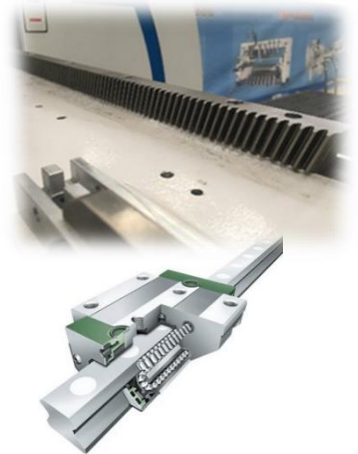

German IGUS flexible cables are used for their proven reliability in this high wear area

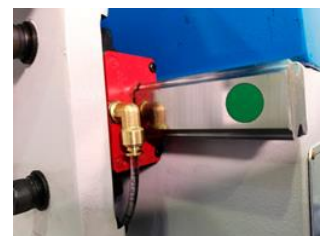
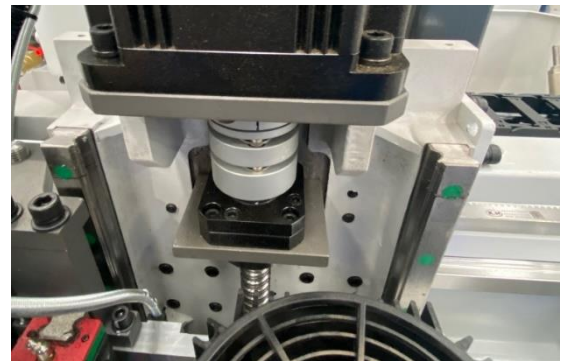

100m/m min X / Y travel boosts output



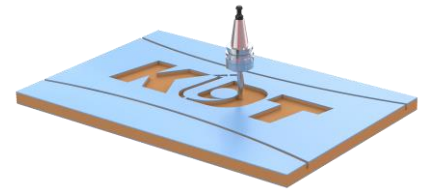

KN3409DE Flat Panel Nesting CNC.
Strong, Precise and Outstanding value

12 Tools on board and measured!

Travelling with the Gantry is a 12 station Servo drive (fast) Rotary auto tool changer supplied with 12 x ISO30 system tool holders and collets.

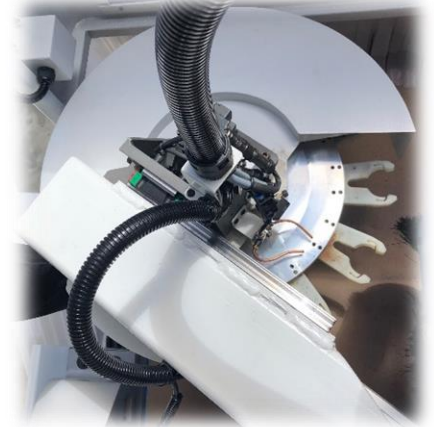
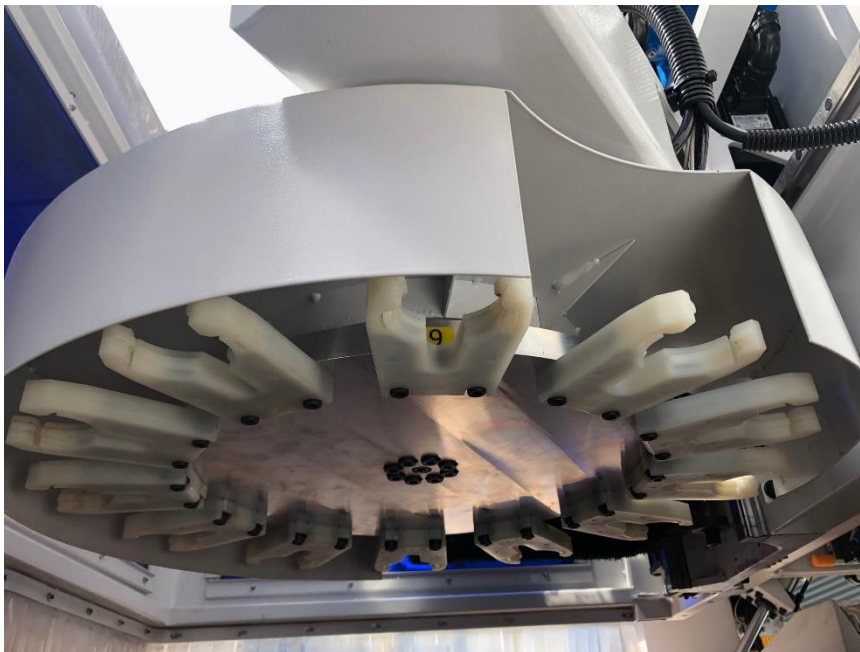

To eliminate guess work and trial cuts a tool length measuring device allows even large tools to be automatically and easily measured

The basic tooling to get you started is included



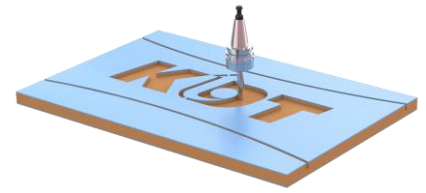

KN3409DE Flat Panel Nesting CNC. Strong, Precise and Outstanding value

Powerful 12kw Electro Spindle

KDT'S 12KW air cooled Electro Router spindle has step-less Inverter control from 3,000 to 24,000 rpm by Inverter. You always have the correct rotation speed for the optimum routing result.

KDT's spindles have a well-earned reputation for quality and longevity with every mechanical, pneumatic and electronic component undergoing a rigorous double testing program



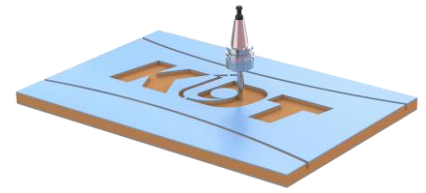

KN3409DE Flat Panel Nesting CNC. Strong, Precise and Outstanding value

Drilling Versatility.

The 10 Independent drills make short work of your drilling, line boring and hinge hole machining

6 in X and 4 in Y at 32mm spacing is both practical and versatile,

Spindles rotation at 6000rpm via a powerful 1.7kw motor ensures clean fast boring.

An efficient dedicated dust extraction hood to the boring head with pneumatic activation leaves a clean finish

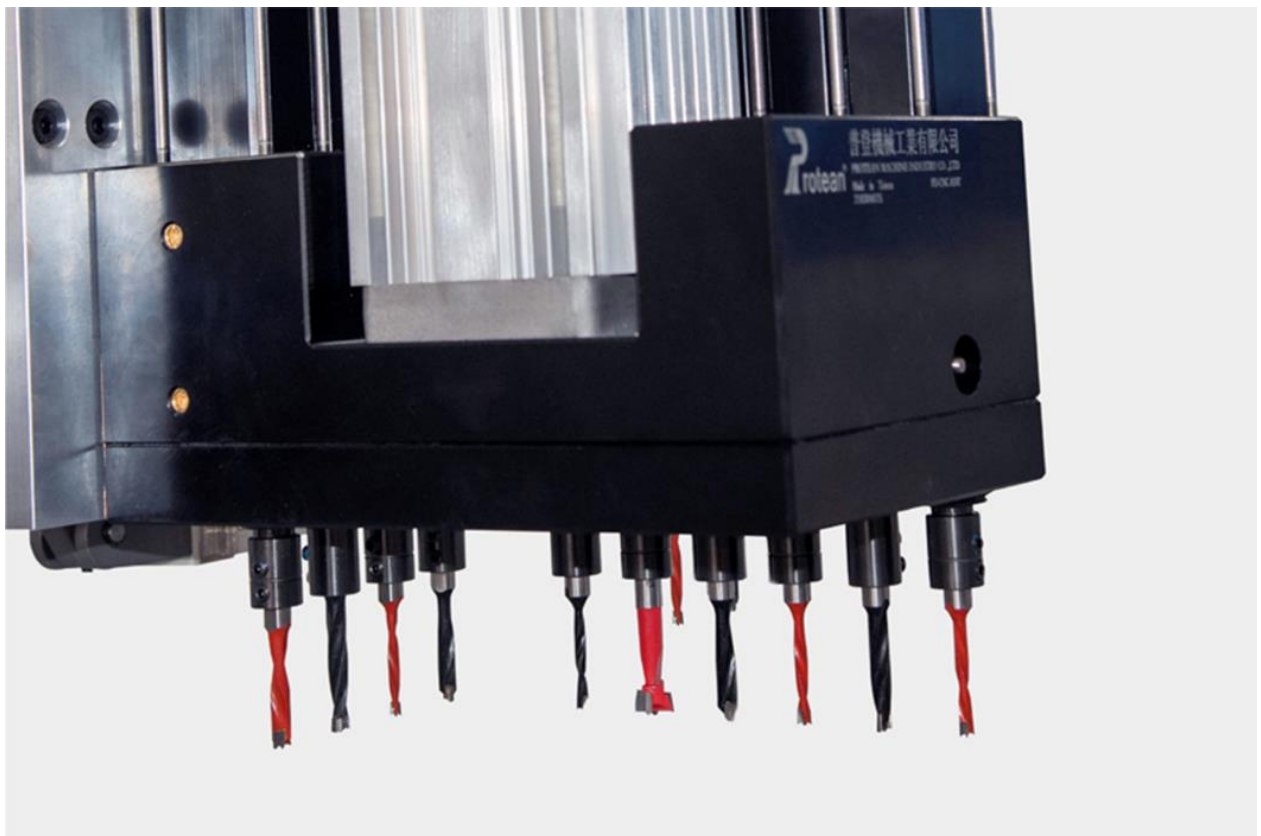

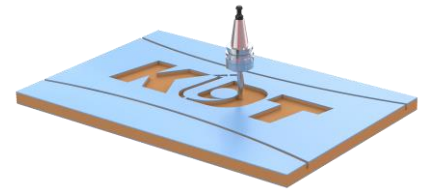

KN3409DE Flat Panel Nesting CNC. Strong, Precise and Outstanding value

Dust extraction is important

KDT understand the importance of extraction that works effectively without the need for substantial extraction volumes. Removing chips and dust from working surfaces is critical to good routing results

Independent and close-fitting hoods on the Router and boring head switch pneumatically dependent on which unit is working. The auto panel pusher has its own extraction that also automatically opens only when needed

The result: just a single 200mm connection and 3400 cubic m per hour extraction volume
Class Leader!



Additional blowing of the processing zone ensures effective removal of chips from the cutting zone, which significantly affects the quality of processing and tool life.



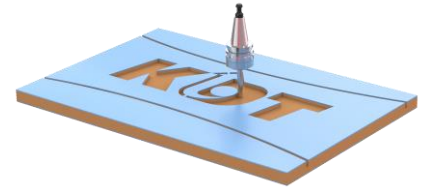

KN3409DE Flat Panel Nesting CNC. Strong, Precise and Outstanding value

Operator and Machine interface > Easy

KDT use the latest DELTA machine controller with a reputation for reliability and user-friendly format. ‘

Your fully fledged command centre



A DELL PC makes updates easy while providing a familiar user-friendly interface. The DELTA controller will work with all recognised Kitchen Design/ Cabinet, CAD software.

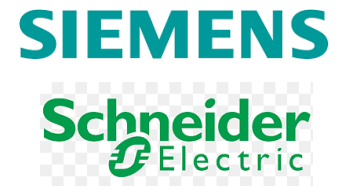

Electronic components from trusted international suppliers are housed in a separate cabinet.

Filtered Industrial fans ensuring the sensitive Inverters, servo drives, and other electronics are kept cool and dust free.

Essential for electronic reliability in an Australian summer.

**Control cabinet is on wheels
– very easy to position and lock
down wherever suits best**

WoodSystem CAD Software –

easy and included



www.ledamachinery.com.au
All features and product specifications subject to change without notice

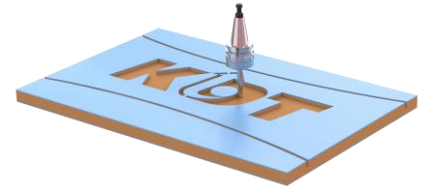

KN3409DE Flat Panel Nesting CNC. Strong, Precise and Outstanding value

WoodSystem allows you to easily program and save a drilling and routing pattern, manage your materials and even Nest the panel machining programs you create.

It's simple, flexible and included – *with options to upgrade its capacity if needed.*

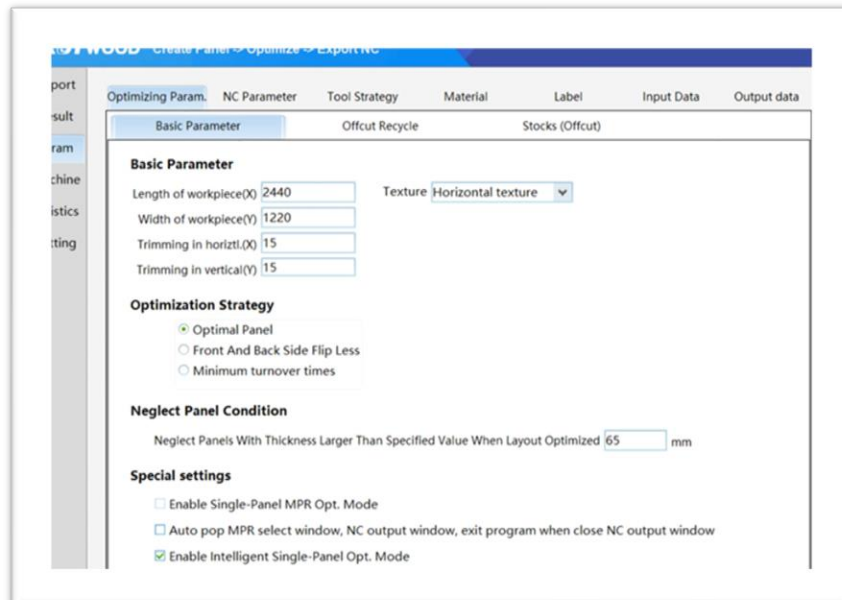
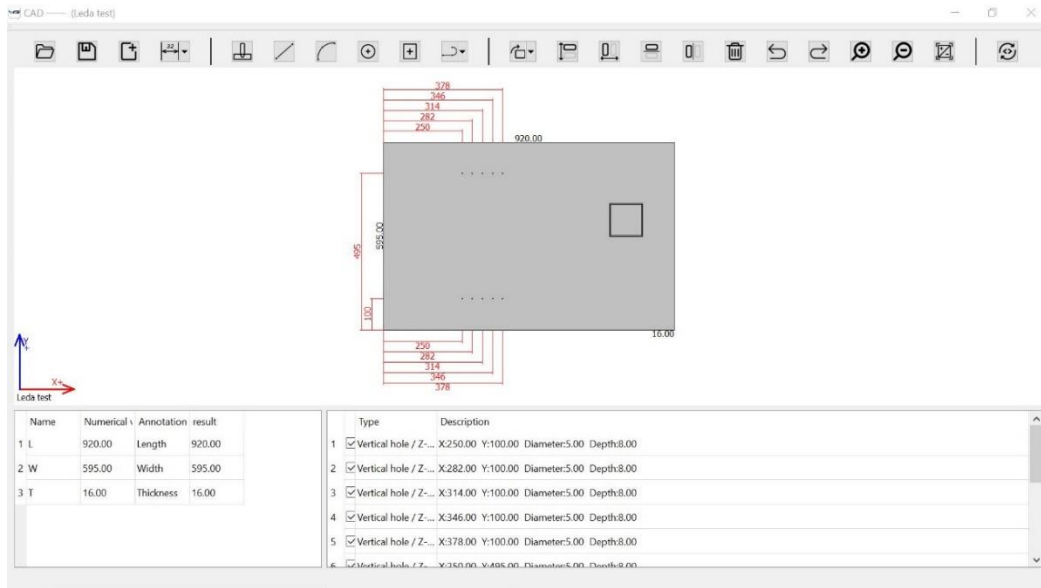

Panel vacuum loading system.



www.ledamachinery.com.au
All features and product specifications subject to change without notice

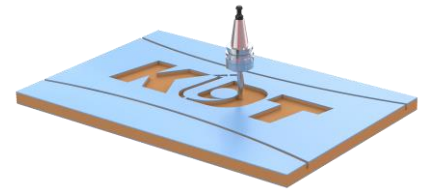

KN3409DE Flat Panel Nesting CNC. Strong, Precise and Outstanding value

The KDT auto load system enables a new panel to be loaded and positioned without operator intervention. Aligning arms 'zero' the panel into machining position automatically

Your table vacuum pump powers the rubber vacuum cups that grip and auto load sheets. This ensures heavy and large panels are loaded without risk of dropping.

A new sheet is loaded at the same time as the completed nest is pushed off:

20-30% productivity boost!

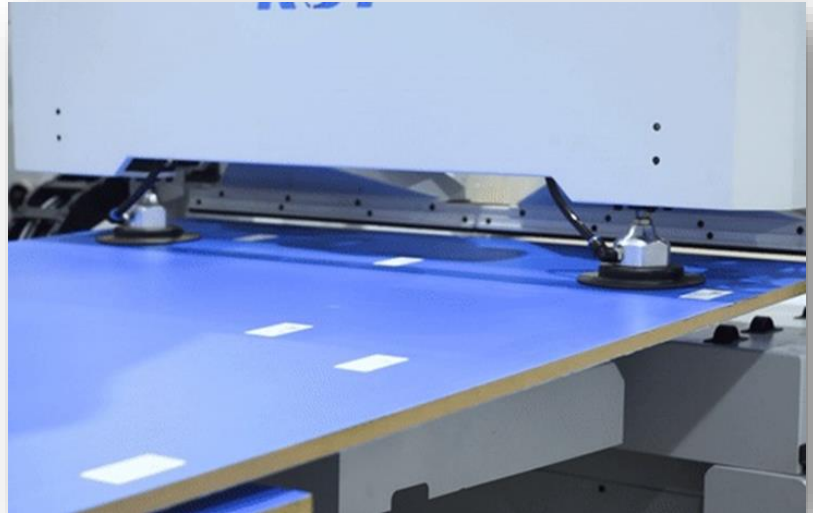

Auto Nest push off – huge productivity boost.



A smart unloading pusher with built in extraction pushes the completed nest to a sorting table. You can immediately load a new panel and commence your next nest effectively doubling your output.



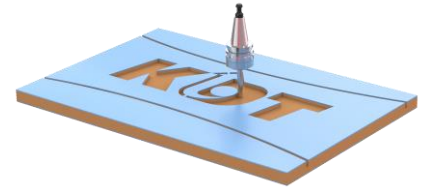

KN3409DE Flat Panel Nesting CNC. Strong, Precise and Outstanding value

A pneumatic on/off gate makes efficient use of your extraction airflow.



You or we can supply a simple static outfeed sorting table— or KDT have a clever driven outfeed table option with extraction and light sensor control – perfect for JIT labelling



You have the space.

The compact footprint of the KN3409DE suits smaller workshops where floor space is tight.

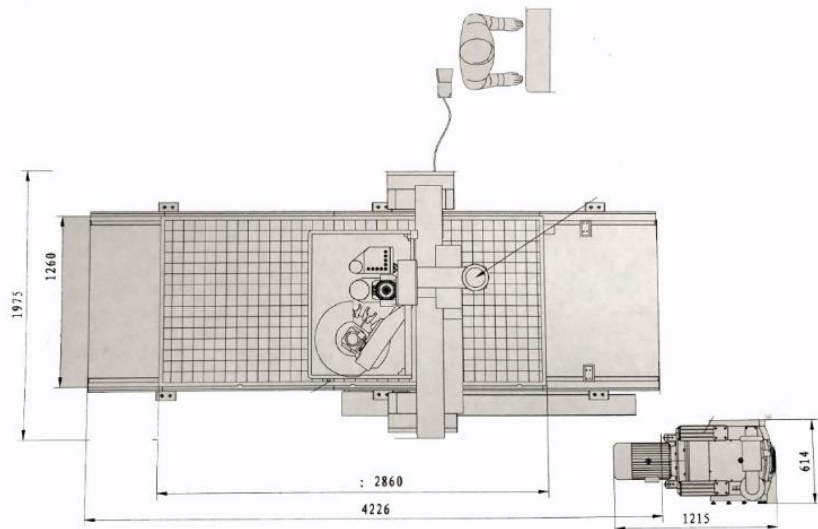

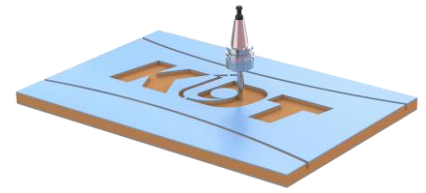

KN3409DE Flat Panel Nesting CNC. **Strong, Precise and Outstanding value**

User friendly wherever you look

A hand control makes machine set-ups easy – a neat touch: its magnetic

The PC control allows LEDA or KDT's Technical support Team to remote connect using 'TEAMVIEWER' should assistance be required.



Other things you will like.

Easy compressed air connection and regulation. Simple, neat and tucked out of harm's way.

Comprehensive tool kit and User manual are supplied

Working area of Y and X axes **2860 mm x 1260mm**

Maximum tool length **100mm**

Maximum travel speed **100m/min in X and Y.**

Maximum travel speed **30m/min in Z**

Maximum cutting speed **25 m/min**

Power requirements **415 volt / 3 phase**

Capacity of vacuum pump **244m³/hr**

Vacuum table zones manually controlled **7 zones**

Air cooled spindle 12 kw **24,000 rpm**

Rotary / servo automatic tool change **12 tool positions**

Servo power X axis 2 x 1.5kw, Y axis 1.5kw, Z axis 1.5kw

Dust hood connection diameter **200 mm: 3400 cubic m/hour**

Machine weight (not including in/out feed) **3500kg**

Transmission for X and Y axis **helical rack and pinion**

Transmission for Z axis **ball screw**

Toolholder system **ISO30**



www.ledamachinery.com.au

All features and product specifications subject to change without notice

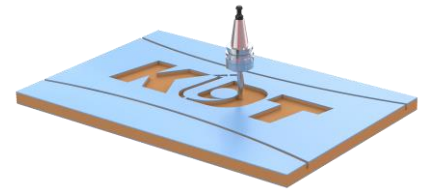

KN3409DE Flat Panel Nesting CNC.
Strong, Precise and Outstanding value

Included:

- **WoodSystem** CAD Software to program drilling and routing patterns
- Outfeed pusher with integrated dust extraction
- Automatic tool length measure
- USB Communication
- Delta PC Controller
- Delta servo drive motors 1.5kw each
- 10 Independent spindle drill head
- 12 x ISO30 tool holders and chucks

Safety fences and light barriers are standard equipment



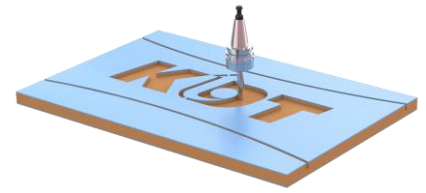

KN3409DE Flat Panel Nesting CNC. Strong, Precise and Outstanding value

Productivity boosting Options:



Hydraulic lifting table

Auto - height sensing maintains the correct stack height as panels are removed.

Safety valves to the hydraulics and an operator safety stop bar are included.
Sturdy rear bollards make positioning a pack of board simple for the forklift driver.

Combined with the auto loading and alignment system that comes standard - you now have a fully automated panel loading system.



CNC Label print / place System Automatic at infeed

Fast and effective. Auto label turning and monitoring of successful label placement

Outfeed manual place Label system also available



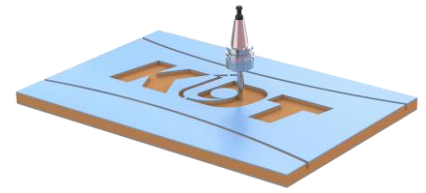

KN3409DE Flat Panel Nesting CNC. Strong, Precise and Outstanding value

Outfeed table – driven conveyor

An automatic stop/start system using optical sensors at the offload end detect panels > the panels present themselves at the end of the table for unloading without any chance of outpacing the operator.

Can be combined with Label printing with Touchscreen control at the outfeed.



Outfeed table – Static
Very economical and effective

